

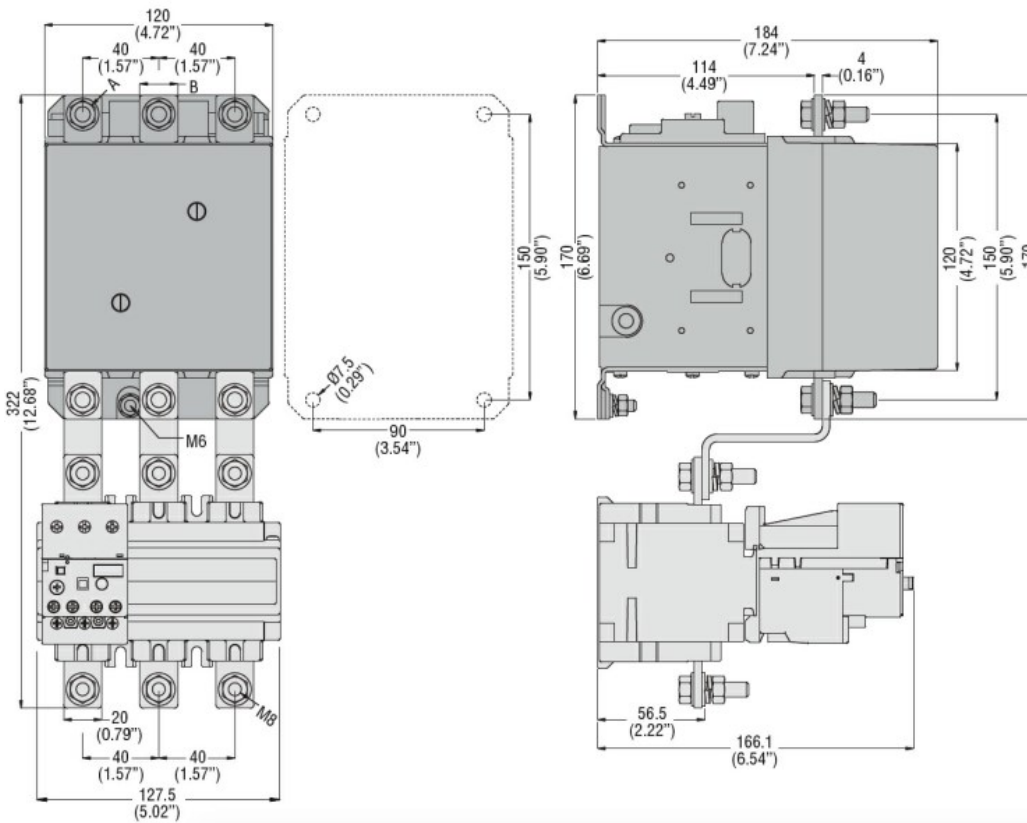

Product designation	RF200		
Product type designation	Motor protection relay		
General characteristics			
Number of poles	Nr.	3	
Overvoltage category	III		
Pollution degree	3		
Frontal IP degree	IP20		
Type of release	Thermal		
Protection fuse			
	gG (IEC)	A	200
	aM (IEC)	A	125
	K5 (UL)	A	500
Phase failure detection	no		
Reset mode	Manual or automatic		
Power circuit characteristics			
Rated insulation voltage U_i IEC/EN	V	1000	
Rated impulse withstand voltage U_{imp}	kV	6	
Rated operational voltage	V	690	
Operational frequency			
	min	Hz	50
	max	Hz	60
Operational current I_e			
	Operational current min	A	75
	Operational current max	A	125
Tripping class	10A		
Test Button	yes		
Trip indicator	yes		
Terminals			
	type	screw and flat washer	
	screw	M8	
	width	mm	20
	tool	Bar 13mm	
Tightening torque for terminals			
	min	Nm	18
	max	Nm	18
	min	lbin	13.3
	max	lbin	13.3
Auxiliary circuit characteristics			
Auxiliary contacts			
	NO	Nr.	1
	NC	Nr.	1
Auxiliary Rated insulation voltage U_i IEC/EN	V	690	

Auxiliary Rated impulse withstand voltage Uimp		kV	6
Auxiliary Rated operational voltage		V	690
Operating current AC15	24V	A	3
	120V	A	3
	240V	A	1.5
	380V	A	0.95
	480V	A	0.75
	500V	A	0.72
Operating current DC13	600V	A	0.6
	125V	A	0.11
	600V	A	0.22
IEC Conventional free air thermal current Ith		A	10
Terminals			
	Auxiliary circuit type		screw and washer
	Auxiliary circuit screw		M3,5
	Auxiliary circuit width	mm	8
	Auxiliary circuit tool		Phillips 2
Conductor section			
	Auxiliary circuit Flexible w/o lug max	mm ²	2.5
	Auxiliary circuit Flexible c/w lug max	mm ²	2.5
Tightening torque for terminals			
	Auxiliary circuit min	Nm	0.8
	Auxiliary circuit max	Nm	1
	Auxiliary circuit min	lbin	0.59
	Auxiliary circuit max	lbin	0.74
UL/CSA and IEC/EN 60947-5-1 designation			B600-R300
Ambient conditions			
Operating temperature			
	min	°C	-25
	max	°C	60
Storage temperature			
	min	°C	-50
	max	°C	70
Compensation temperature			
	min	°C	-20
	max	°C	60
Max altitude		m	3000
Mechanical features			
Operating position			
	normal allowable		Vertical plan ±30°
Fixing			Screw
Weight		g	2150
UL technical data			
Full-load current (FLA) for three-phase AC motor			
	at 480V	A	125
	at 600V	A	125
Dimensions			



CONTACTOR TYPE	A	B
B115	M6	15 (0.59")
B145	M8	20 (0.79")
B180	M8	20 (0.79")

Wiring diagrams

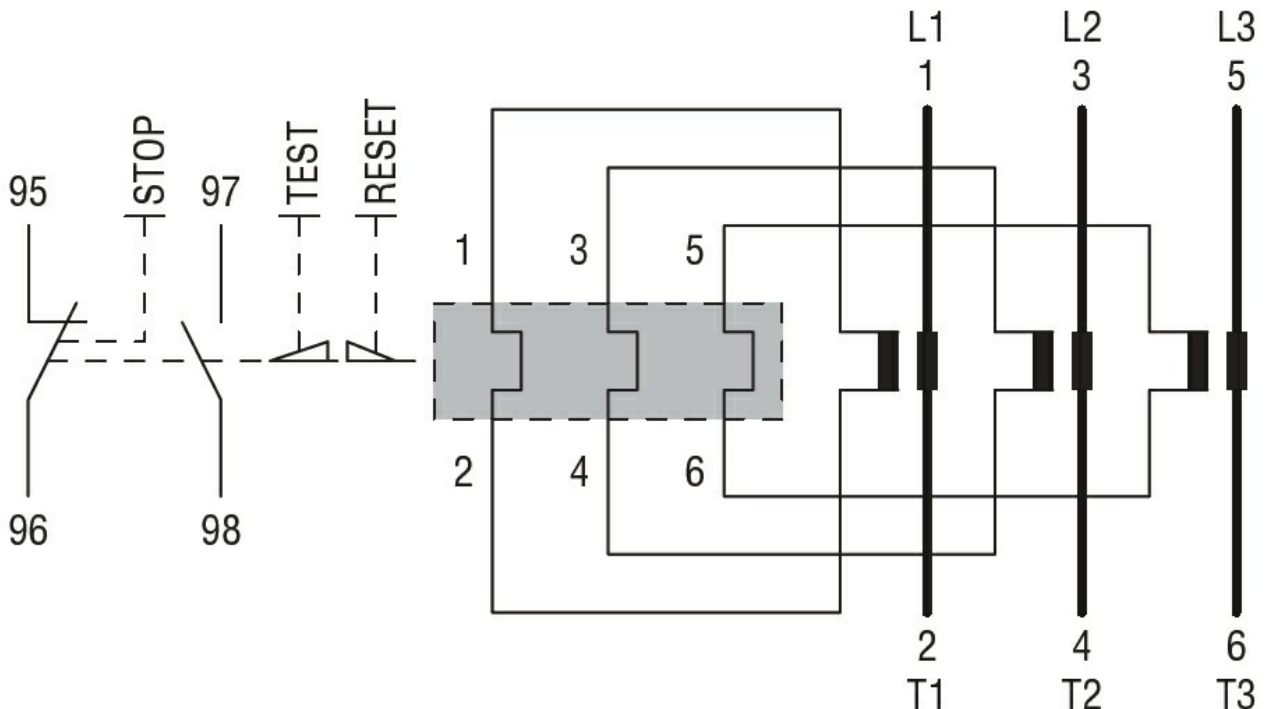

Certifications and compliance

Compliance

CSA C22.2 n° 14

IEC/EN 60947-1

IEC/EN 60947-4-1

UL508

Certifications

cULus
EAC

ETIM classification

ETIM 8.0

EC000106 -
Thermal overload
relay